

Vedlegg 4 til UD 9-17-3

TAKET PÅ FOREBRUBUS MALES I SAMME
MØNSTER SOM TÅRSKJEREN

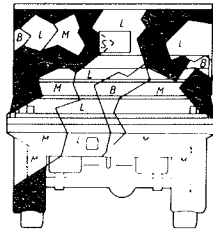
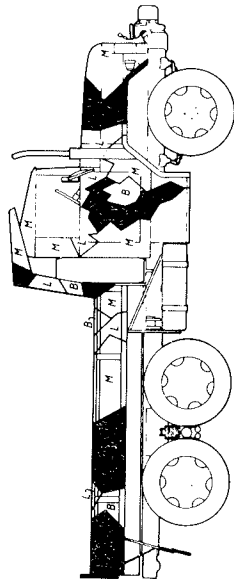
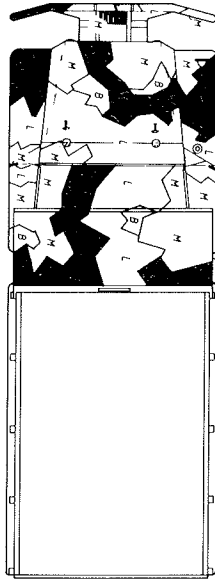
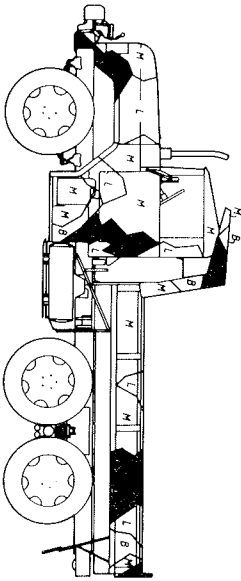
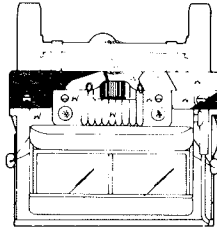

M 624

Vedlegg 4 til UD 9-17-3

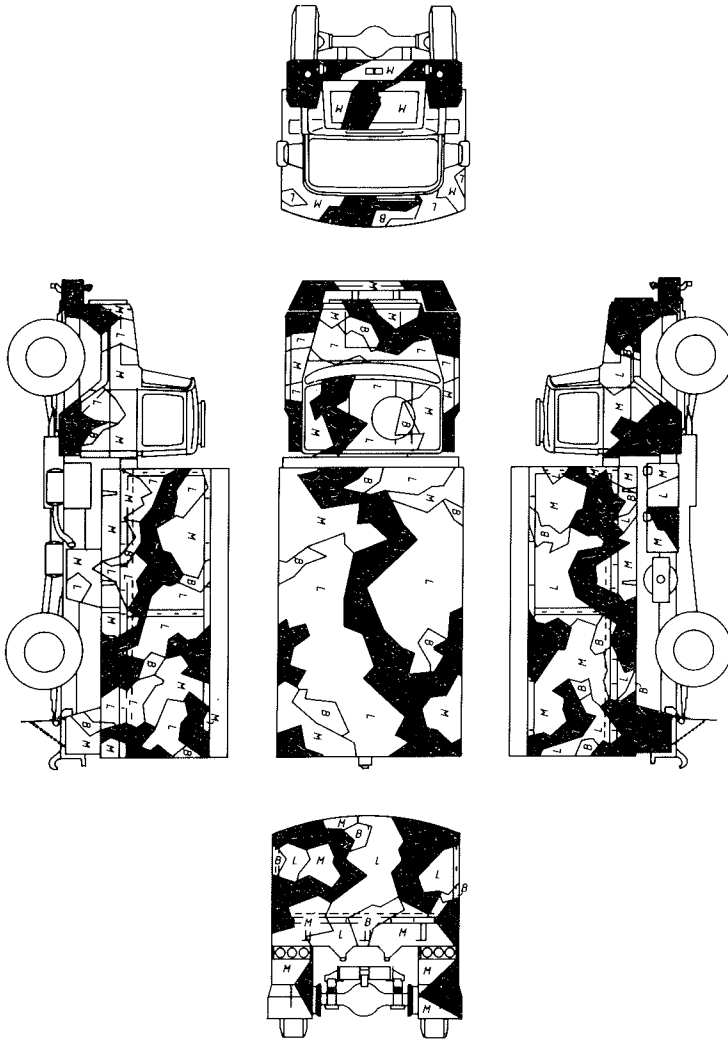

MAGIRUS 4x4

Vedlegg 4 til UD 9-17-3

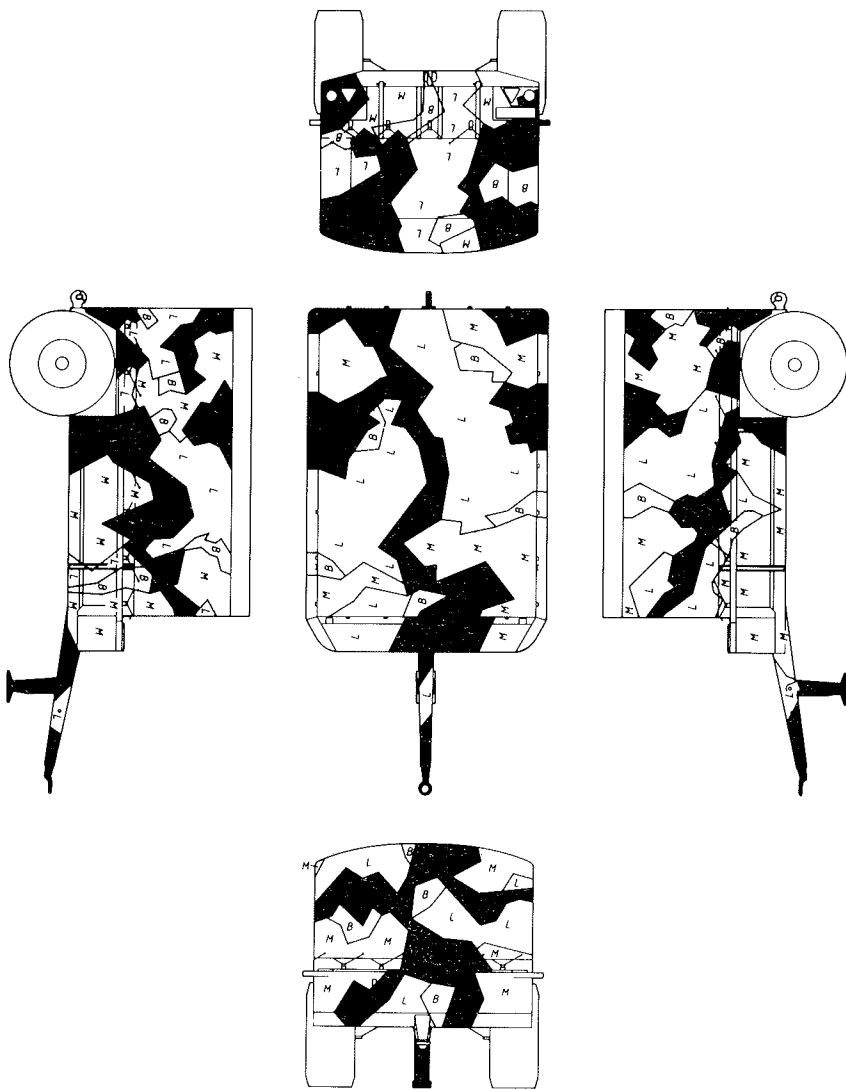

NM 25

Vedlegg 4 til UD 9-17-3

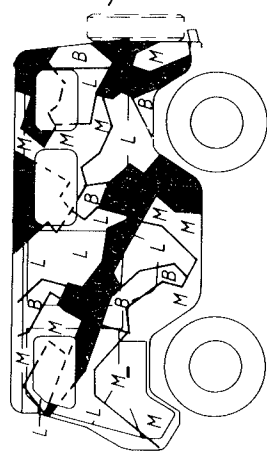
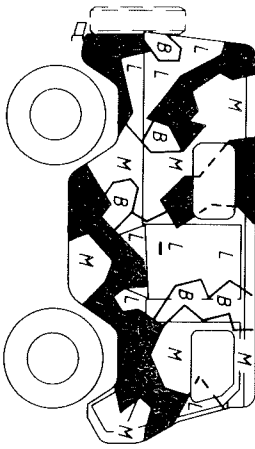

VOLVO 1/2 T 4X4

Vedlegg 4 til UD 9-17-3

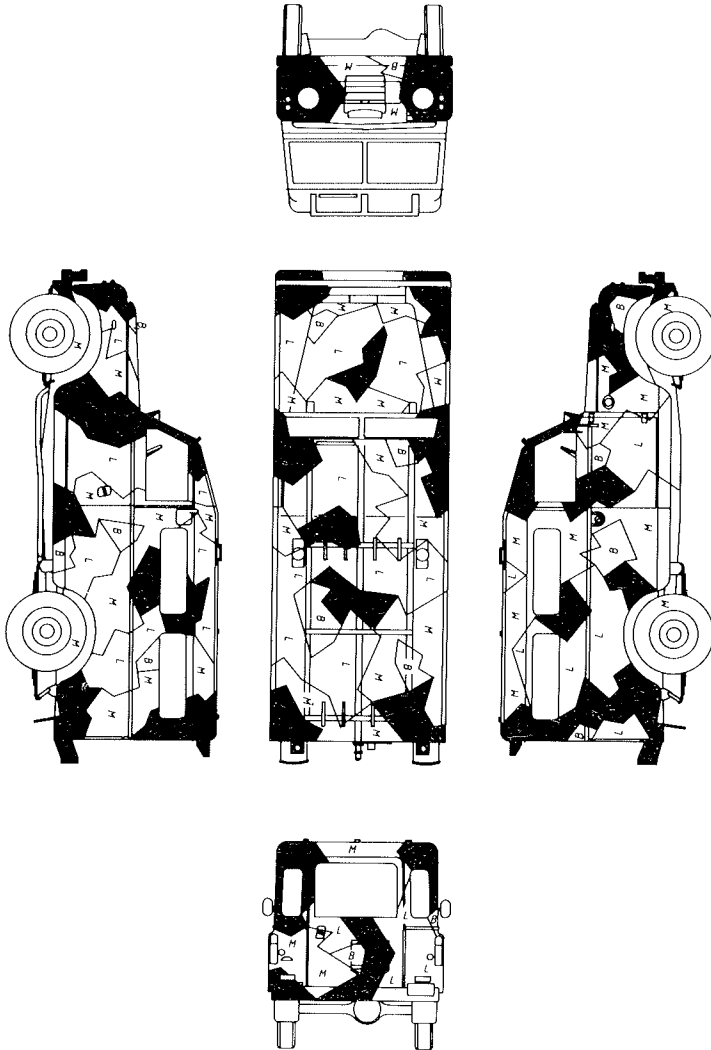

LANDROVER

Vedlegg 4 til UD 9-17-3

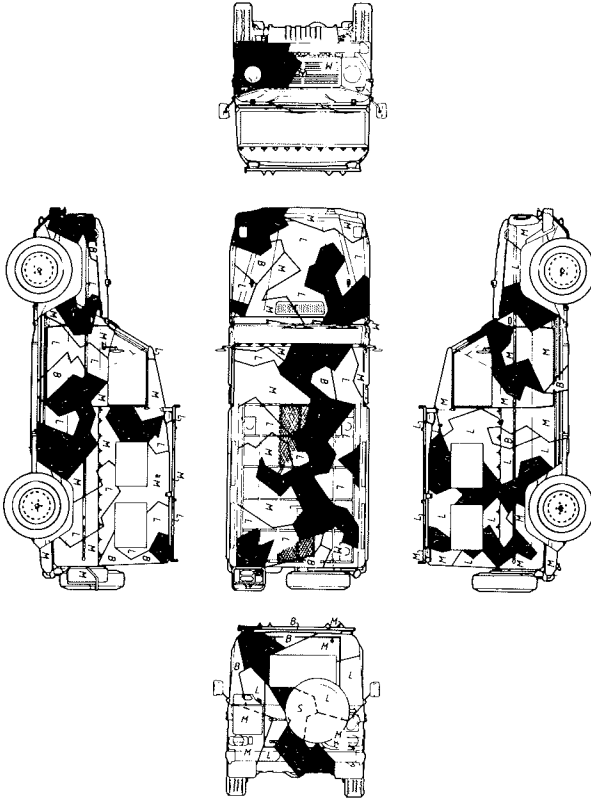

MERCEDES 240 GD

Vedlegg 4 til UD 9-17-3

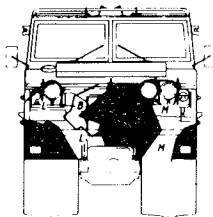
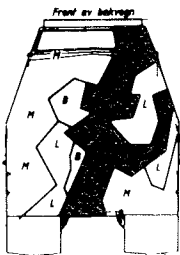
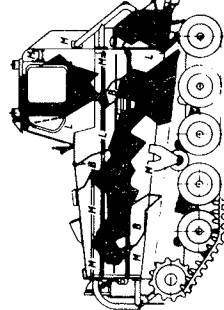
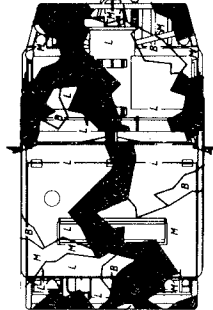
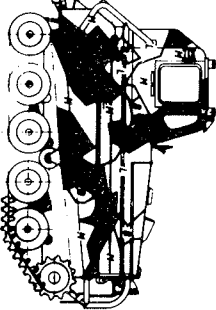
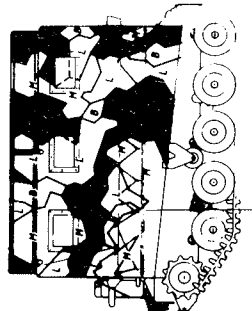
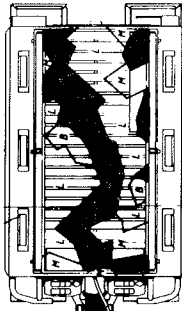
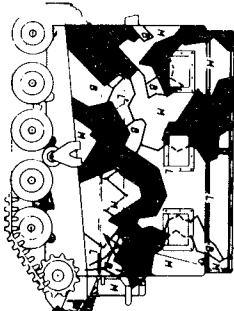

BV 202

Vedlegg 4 til UD 9-17-3

BAKENDE AV FRAMVOGN

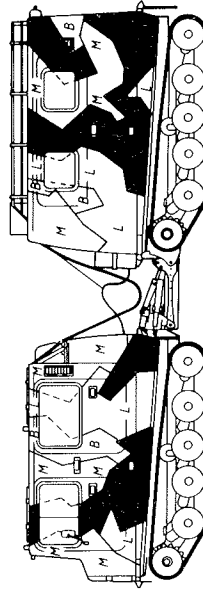
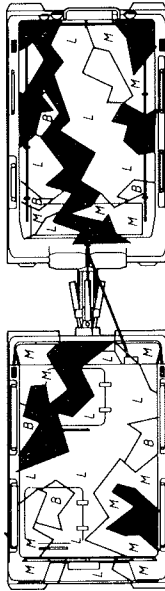
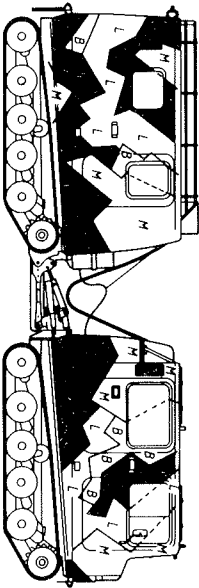
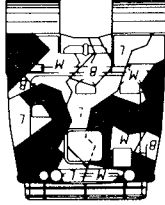
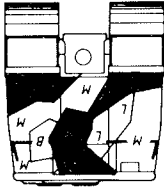

BV 206

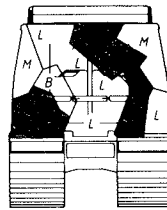
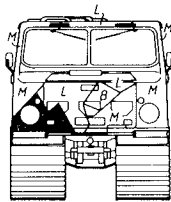

FRONT AV BAKVOGN

Vedlegg 4 til UD 9-17-3

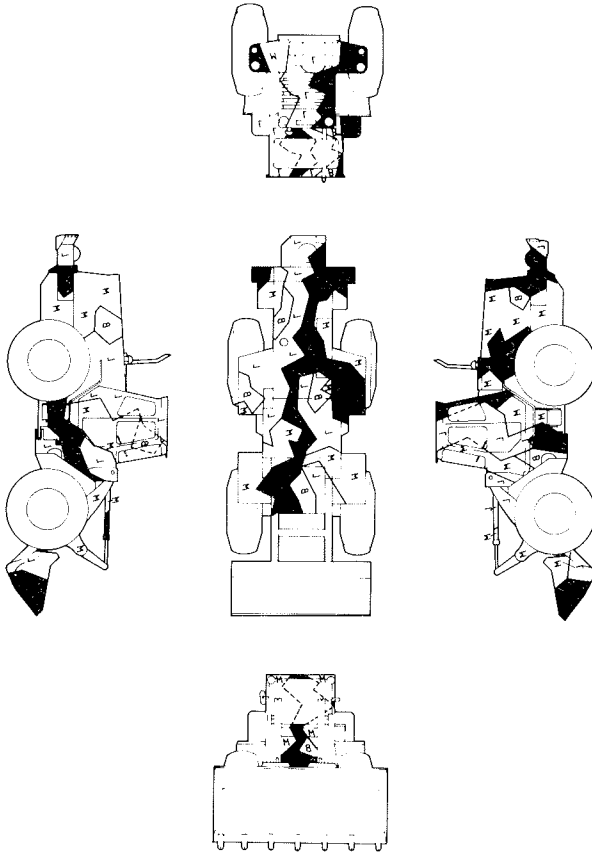

VOLVO LM 846

Vedlegg 4 til UD 9-17-3

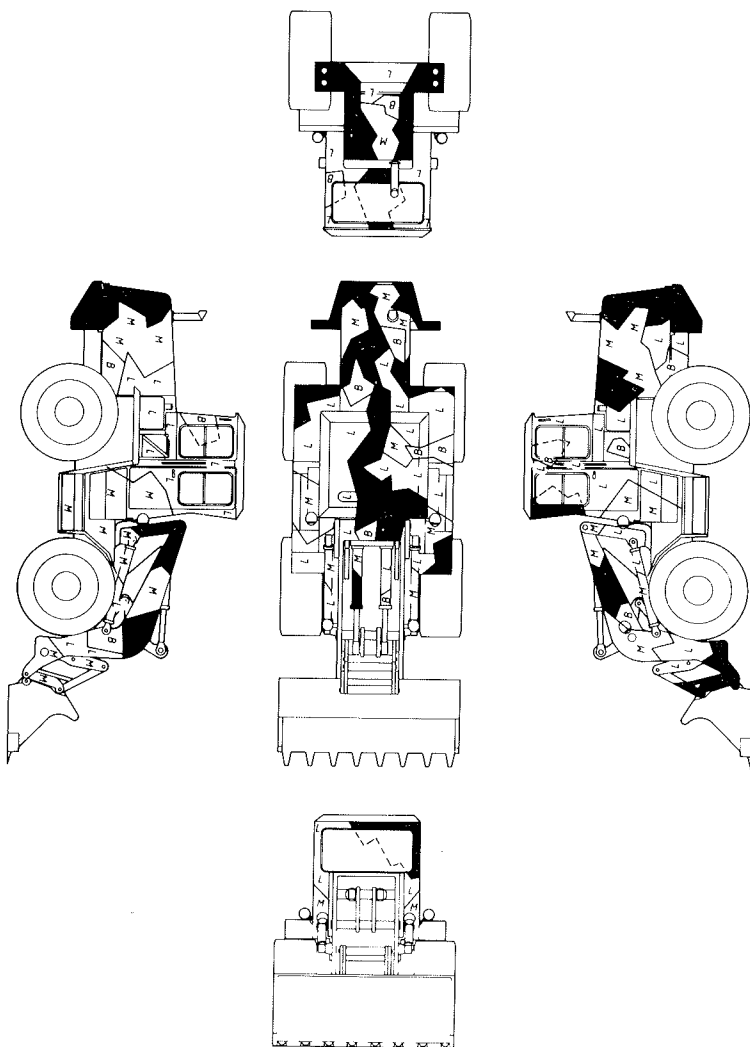

AHLMANN AS 12 B

Vedlegg 4 til UD 9-17-3

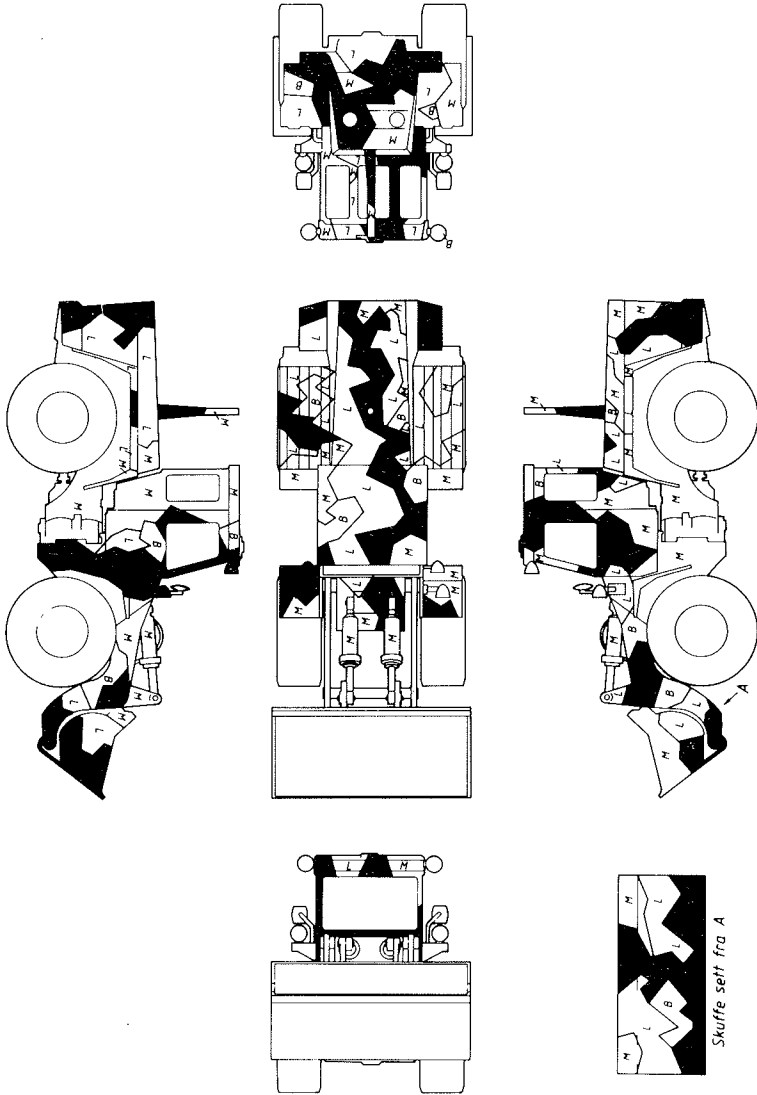

MF 33 C

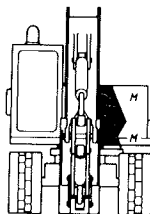
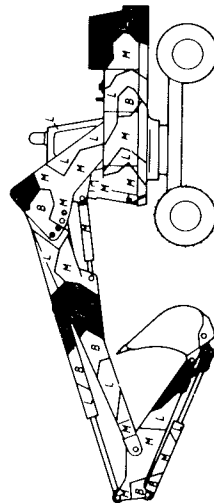
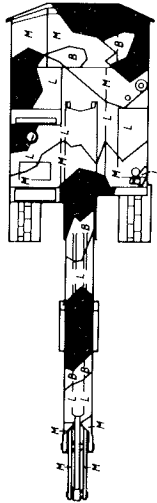
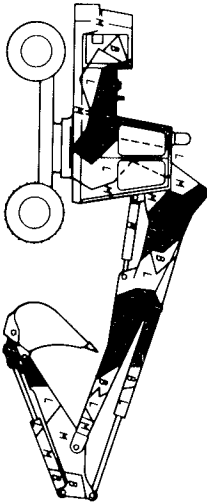
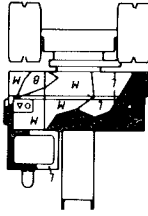

BRØYT X21

Maling under tinner
Tinner svinges og skroper under tinner og
får merkeviser som oppå tinner

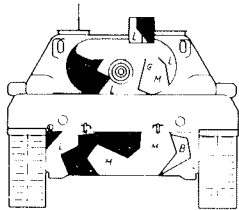
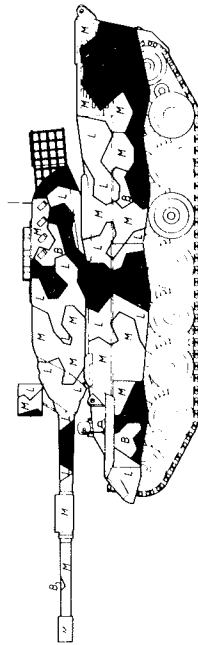
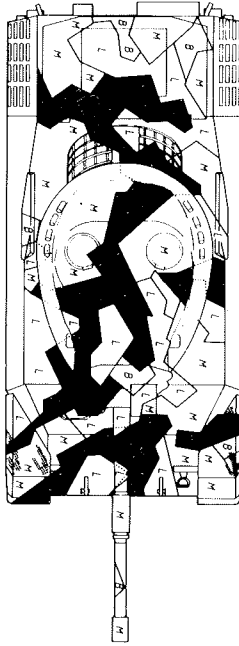
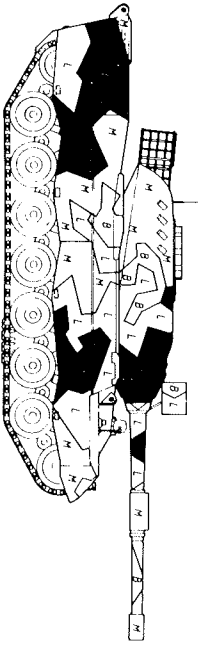
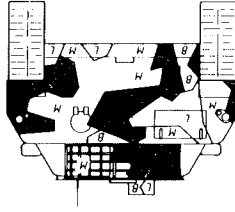

STRV LEOPARD

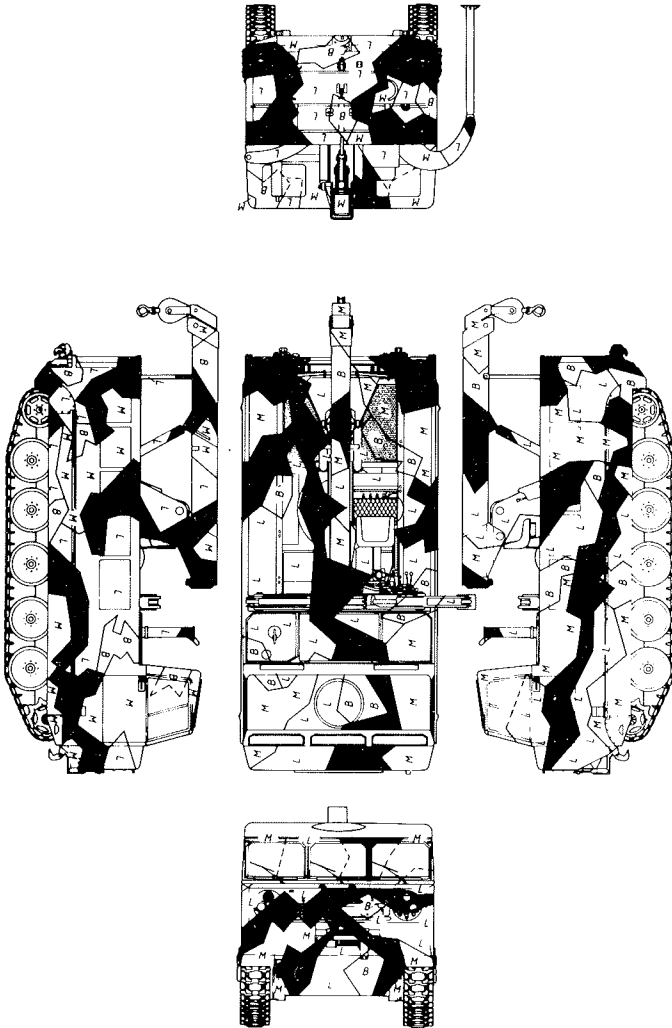

NM 84

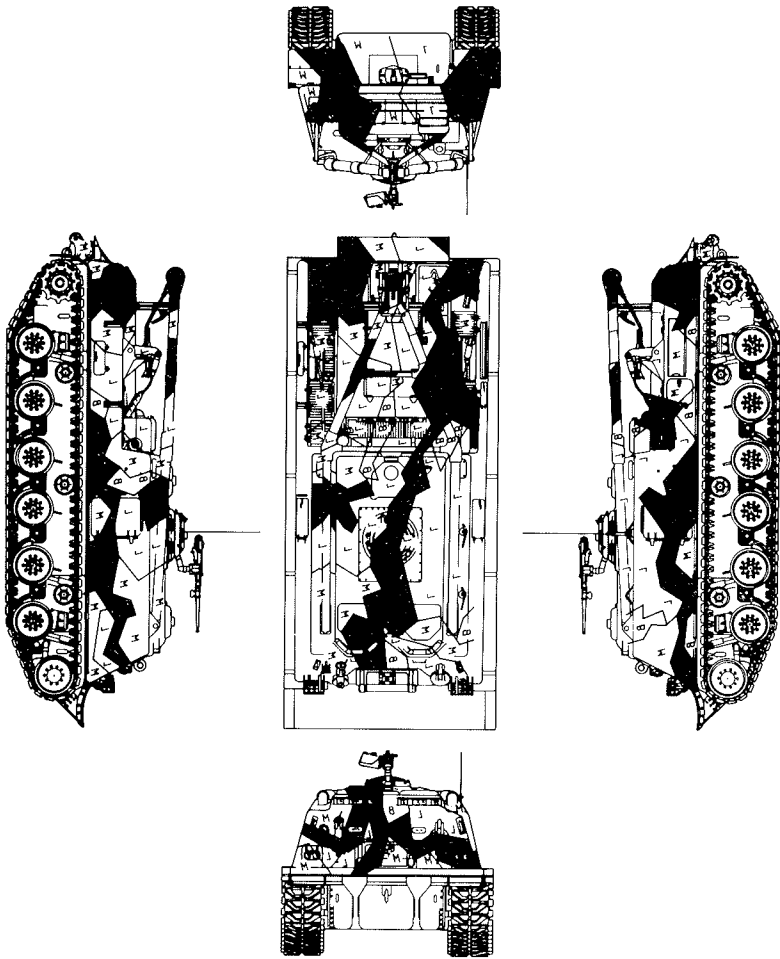

M 88 A 1

Vedlegg 4 til UD 9-17-3

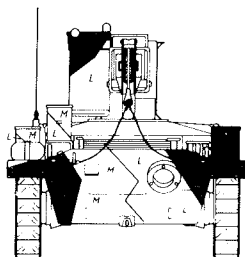
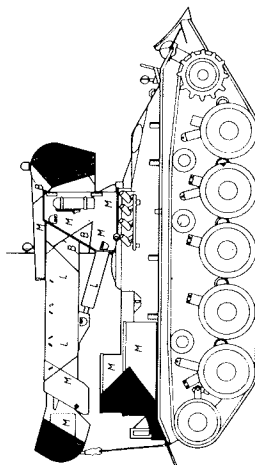
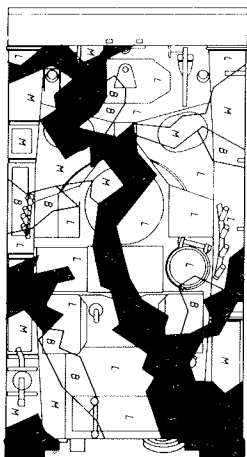
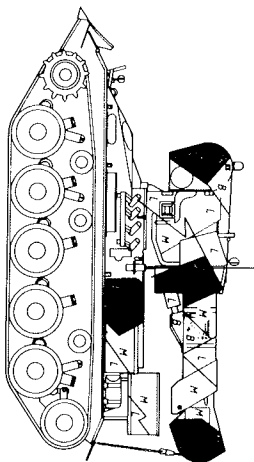
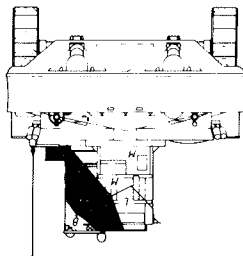

Vedlegg 4 til UD 9-17-3

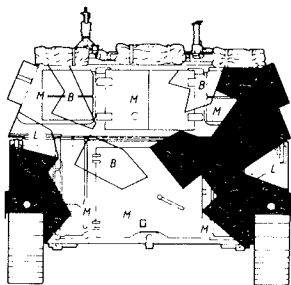
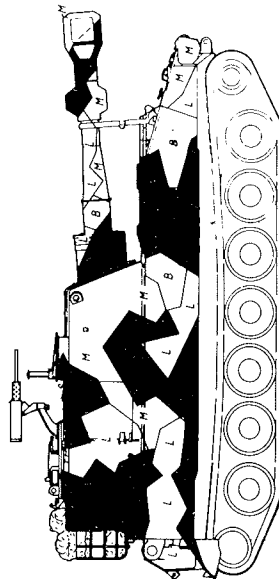
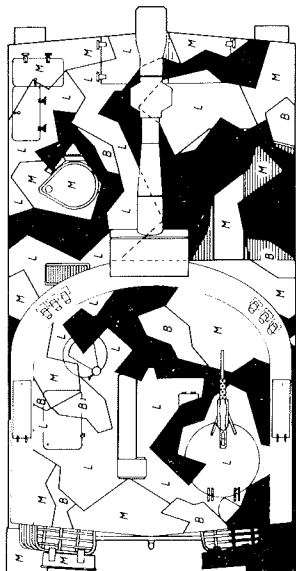
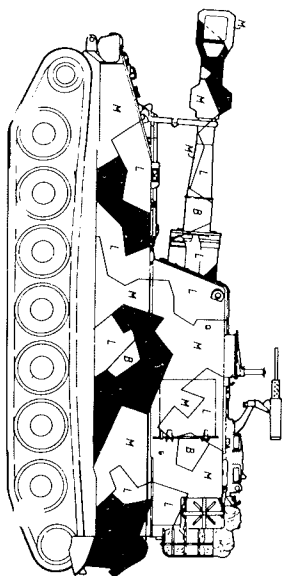
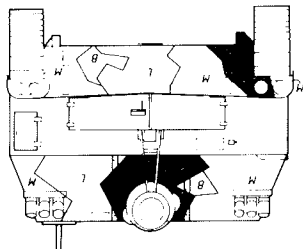

Vedlegg 4 til UD 9-17-3

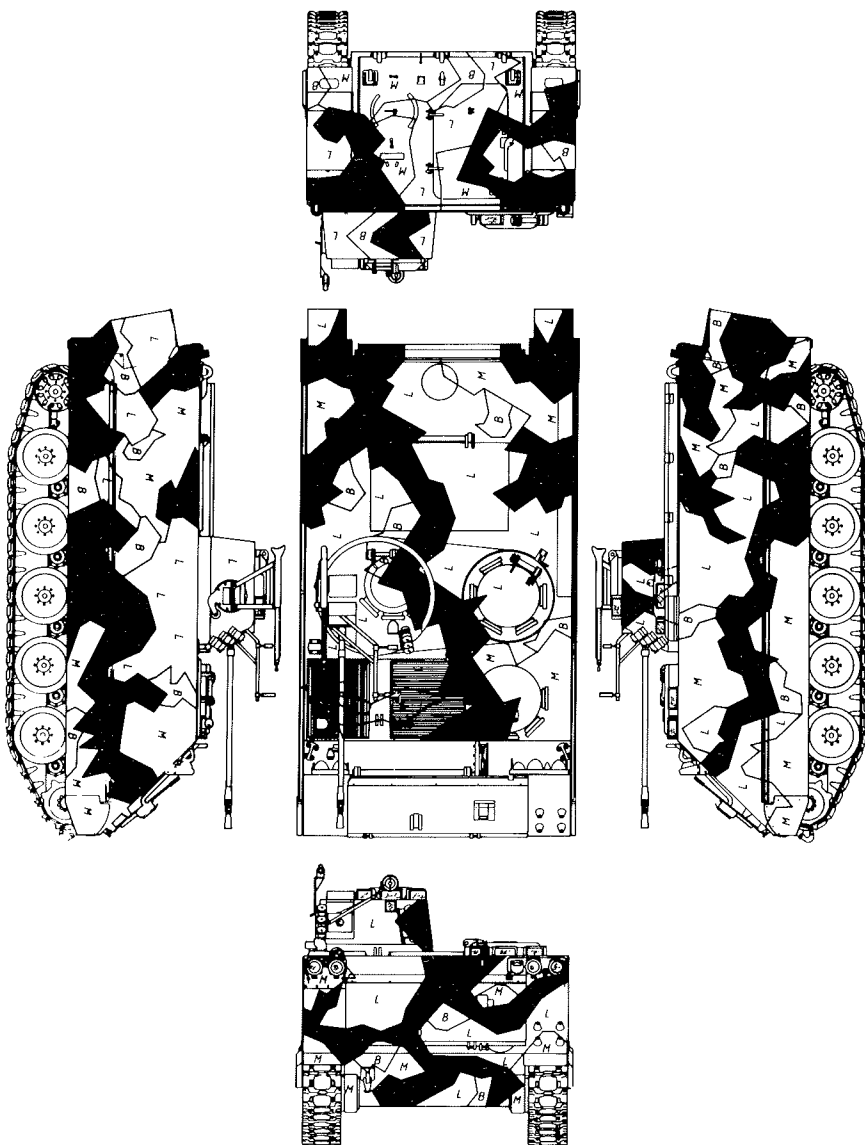

NM 135

Vedlegg 4 til UD 9-17-3

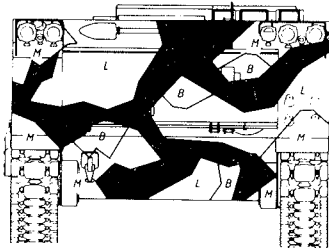
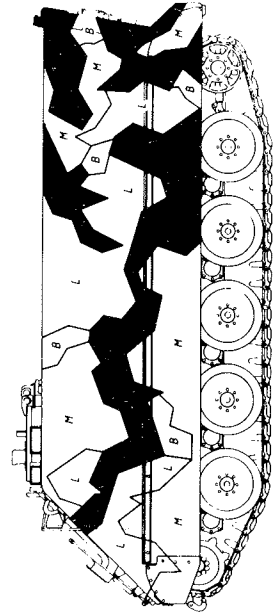
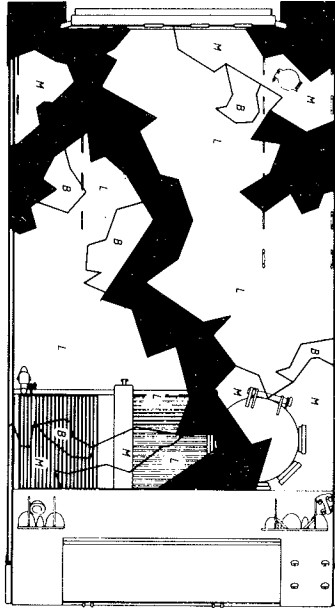
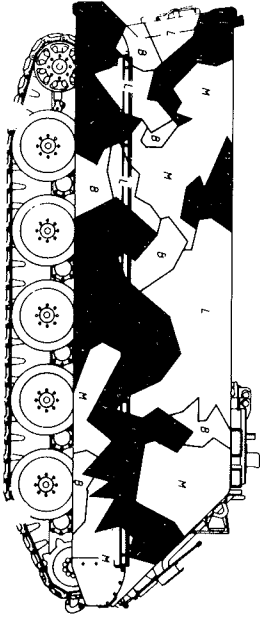
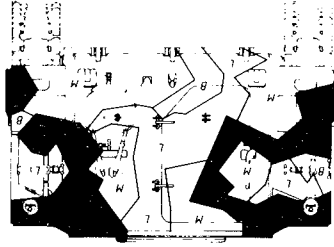

Vedlegg 4 til UD 9-17-3

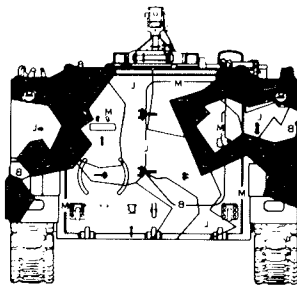
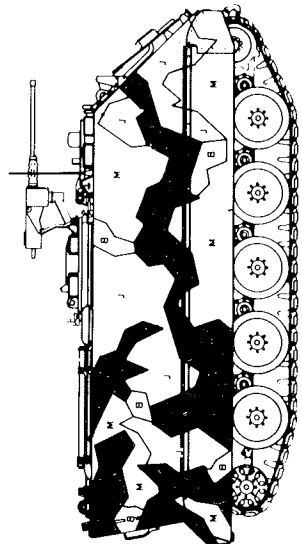
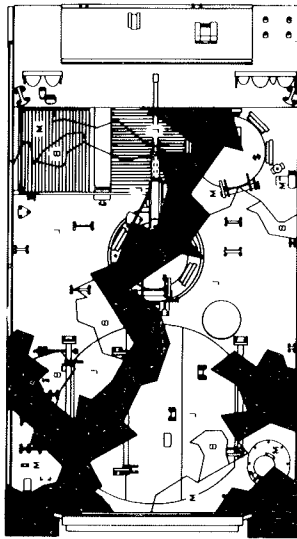
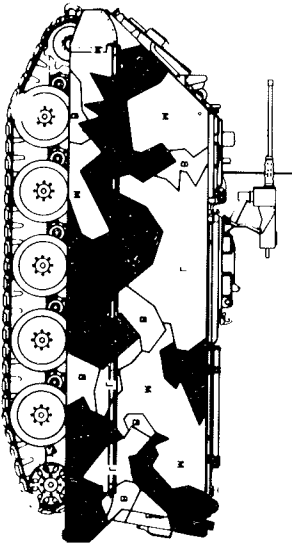
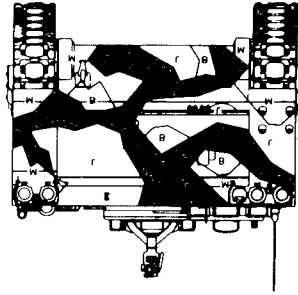

M 106

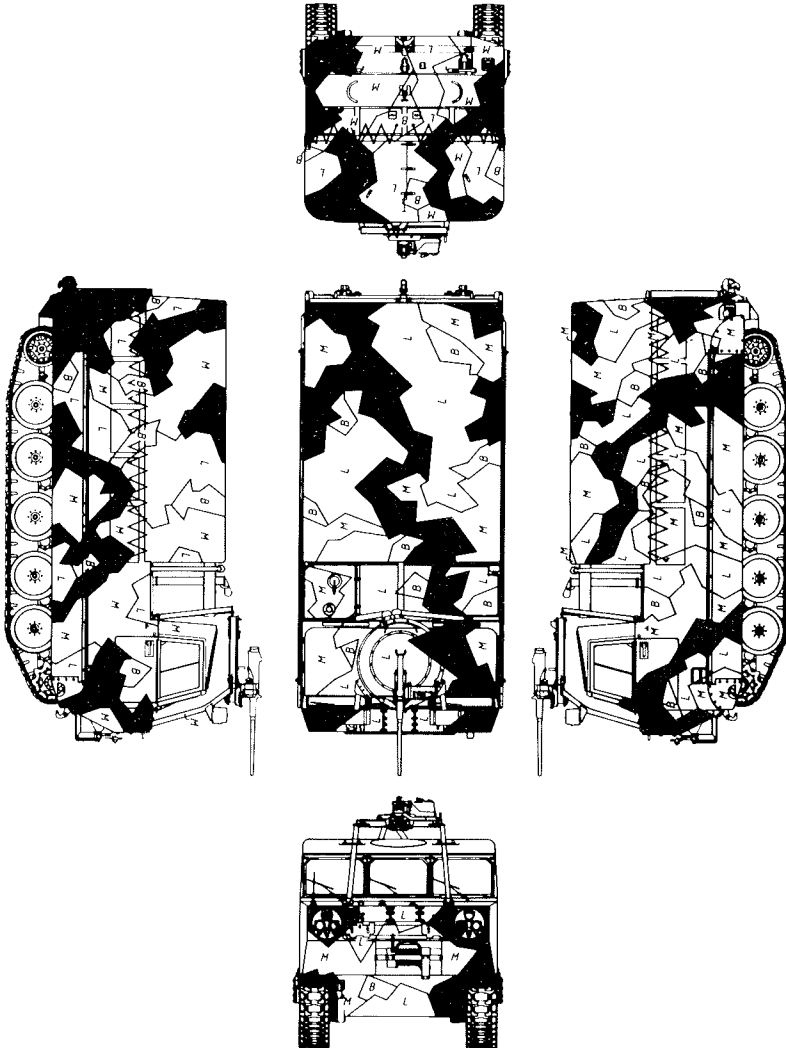

Vedlegg 4 til UD 9-17-3

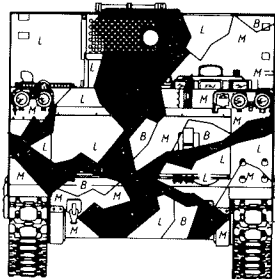
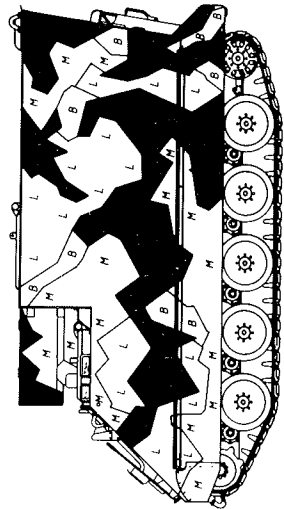
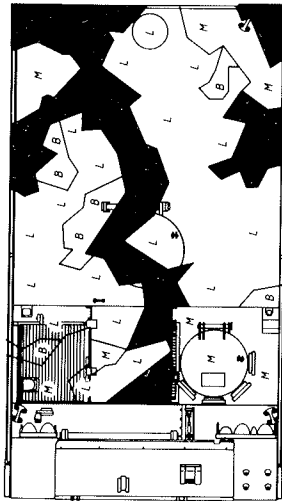
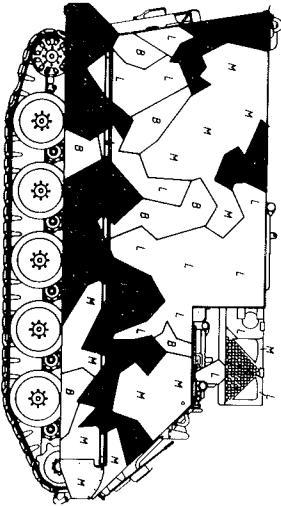
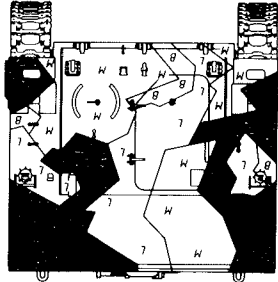

M 577

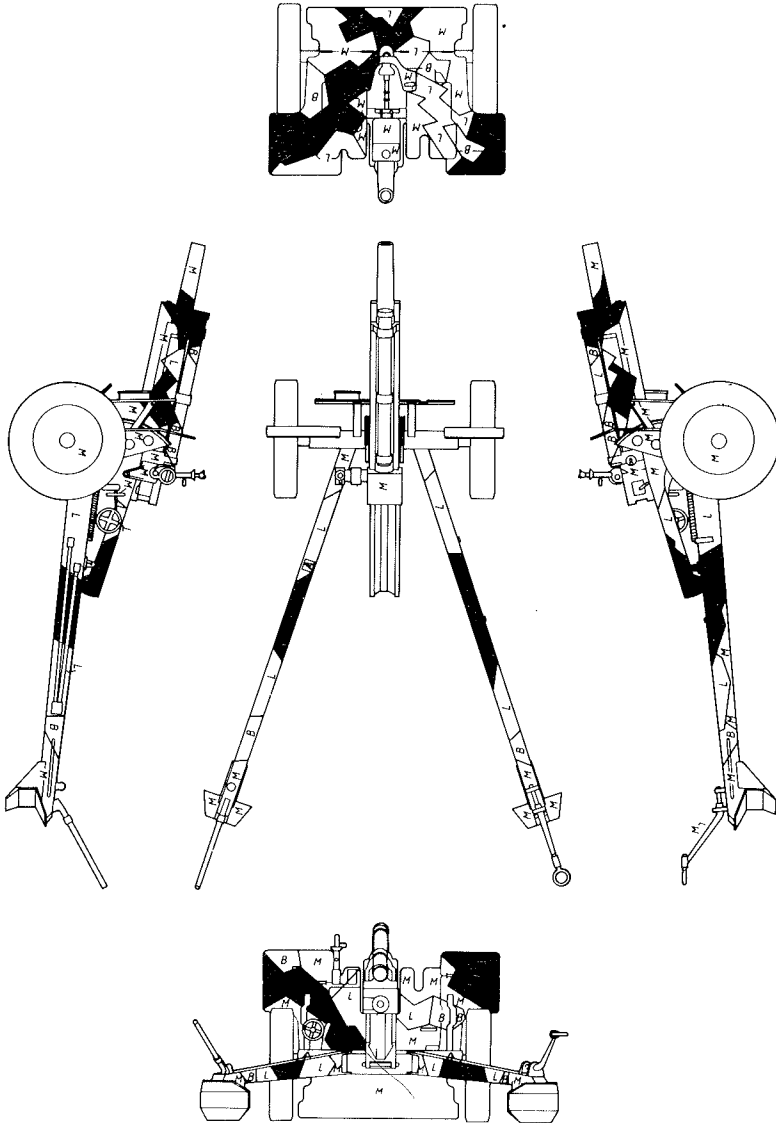

105 mm HAUBITS M 101

Vedlegg 4 til UD 9-17-3

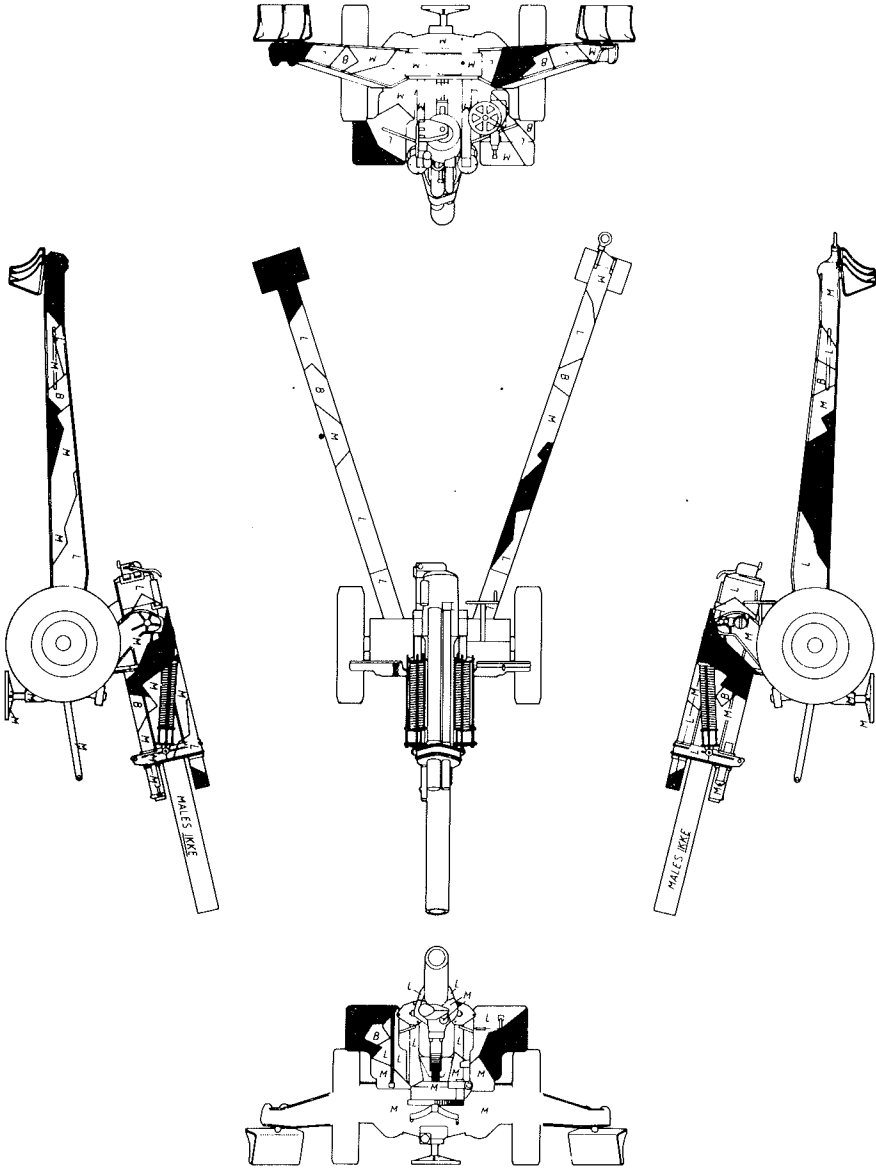

155 mm HAUBITS M 144

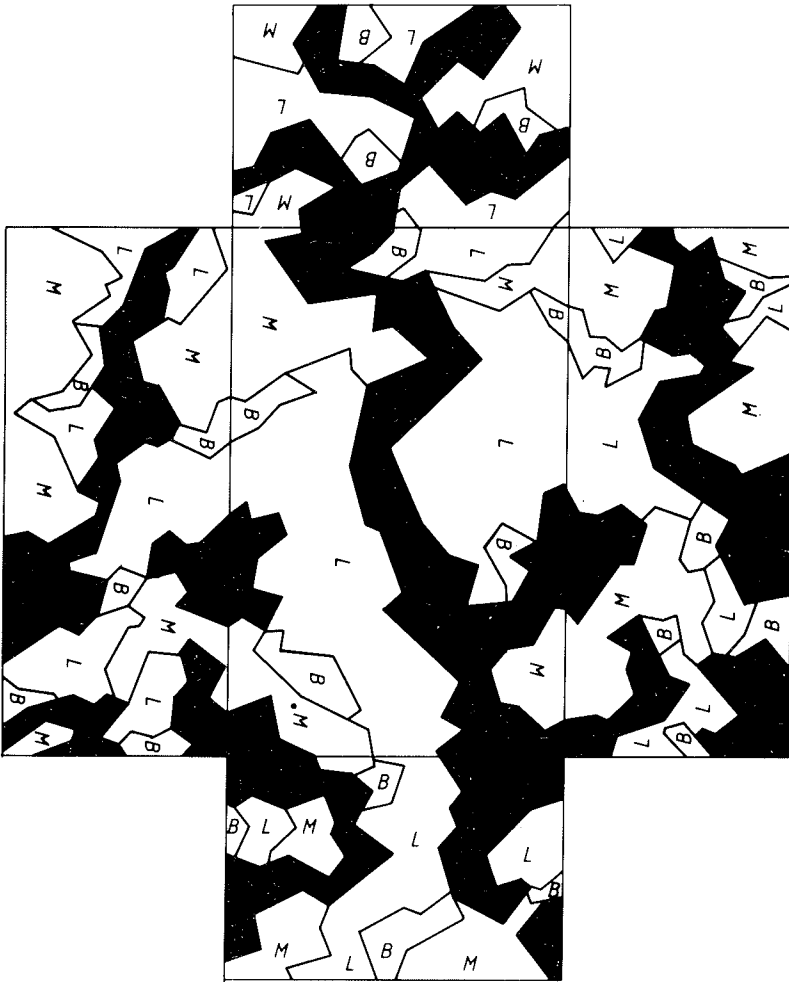

UNIVERSALMØNSTER